



Pendant Aircraft Cable
(PM-AC)



Pendant with Canopy Static
(PM-CS)

TROY PENDANT LED WATTAGES				
SERIES / SIZE	DIMENSIONS	MOUNTING	LED UPLIGHT (LU) WATTAGES	LED DOWNLIGHT (LD) WATTAGES
Bakersfield	7" Dia. x 10"	Pendant Aircraft Cable (PM-AC)	15W	15W
Bakersfield Medium	7" Dia. x 16½"	Pendant Aircraft Cable (PM-AC)	15W / 25W	15W / 25W
Bakersfield Large	7" Dia. x 20"	Pendant Aircraft Cable (PM-AC)	15w / 25W	15w / 25W
Bakersfield X-Large	7" Dia. x 26"	Pendant Aircraft Cable (PM-AC)	15W / 25W / 30W	15W / 25W / 30W
Bakersfield	7" Dia. x 10"	Pendant Static/Swivel (PM-ST/CSW)	N/A	15W
Bakersfield Medium	7" Dia. x 16½"	Pendant Static/Swivel (PEND-ST/CSW)	N/A	15W / 25W
Bakersfield Large	7" Dia. x 20"	Pendant Static/Swivel (PEND-ST/CSW)	N/A	15w / 25W
Bakersfield X-Large	7" Dia. x 26"	Pendant Static/Swivel (PEND-ST/CSW)	N/A	15W / 25W / 30W

Catalog Number

Project Name & Location

Type

Product Specifications

DRIVER: Universal voltage (120~277V) electronic driver with 0-10V dimming is standard. 347 Volt optional for White LED only.

HOUSING: Heavy gauge aluminum cylinder.

FINISH: Powdercoat finish applied over pre-treated surfaces.

LIGHT ENGINE: Energy Efficient LED Downlight (LD) is standard. LED Uplight (LU) is Optional.

LENS: .156" Clear Tempered Glass (85) is Standard.

DISTRIBUTION: Wide (W) Light Distribution or Extra Wide (XW) Light Distribution.

MOUNTING: Aircraft Cable Suspension (PM-AC) or Hang Straight Pendant (PM) with Canopy Static (CS) or Canopy Swivel (CSW-xx) Canopy.

REFLECTOR: .032 Specular Aluminum Standard.

APPLICATIONS: Restaurants, Dining, Foyers, Hallways, Retail, Commercial, Hospitality.

COMPLIANCE: Built to comply with U.S. and Canadian Safety Standards. Suitable for Damp Locations. **Made in USA / Buy America Compliant / Buy American Act.**



order example:

BFL-PM-LD25-XW-CT4-UNV-BZ

SERIES

- BF Bakersfield Series: 10" Long
- BFM Bakersfield Medium Series: 17" Long
- BFL Bakersfield Large Series: 20" Long
- BFXL Bakersfield X-Large Series: 26" Long

MOUNTING

- PM-AC Pendant with Aircraft Cable
NOTE: Selected for Uplight/Downlight Combinations
- PM Hang Straight Pendant Mount
– 24" Stem Length is Standard
– Consult Factory for Other Lengths
– Includes Canopy Swivel Kit (45°)
NOTE: Selected for Downlight Combinations ONLY

LED WATTAGE

Note: Refer to Chart for Size/Wattage Compatibility

- LDxx LED Downlight (xx = Wattage, ex: DN25)
- LUxx LED Uplight (xx = Wattage, ex: UP25)
Note: LED Uplight for PM-AC Only

BEAM SPREAD

Note: See Page 4 for Images / Examples

- S Spot - 16°
- M Medium - 28°
- W Wide - 56°
- XW X-Wide - 74°
- DL Diffusion Lens
– Includes Glare / Dust Control

LED COLOR TEMPERATURE (CCT)

- CT3 ±3000K LED Color Temp
- CT35 ±3500K LED Color Temp
- CT4 ±4000K LED Color Temp
- CT5 ±5000K LED Color Temp
- RGB RGB Color Tuning (Requires 14DIM Option)
- RGBW RGBW Color Tuning (Requires 14DIM Option)

VOLTAGE

- 347 347 Volts
- UNV 120~277 Universal Volt Driver
- 2UNV Two 120~277 Universal Volt Drivers

FINISH

- BK Black
- BZ Bronze
- PA Painted Aluminum
- WHT White
- CC Custom Color (Consult Factory)

DIMMING OPTIONS

Note: 0-10V 100%-30% is Standard

- 0-10D1 0-10VDC LED Dimming Driver (100-10%)
- 0-10D2 0-10VDC LED Dimming Driver (100-1%)
- 12DIM Lutron Dimming
- 14DIM DMX Control

Additional Options on PAGE 2

PENDANT CANOPY SWIVEL KIT

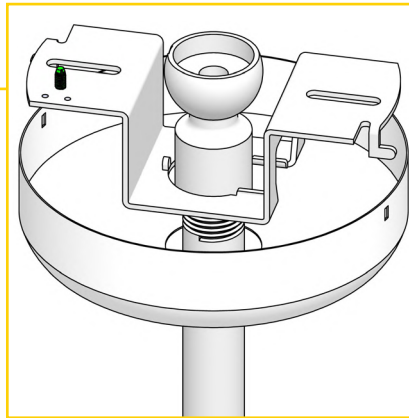

Pendant Mount Includes
Canopy Swivel Kit

EMERGENCY / BATTERY OPTIONS

- No Onsite Emergency (AC / DC) is Provided
- Emergency Battery Options Meet California Energy Commission Title 20 [CEC-400-2014-009-CMF] Efficiency Standards
—Cold Weather Batteries DO NOT meet CEC Standards
- Cold Weather Emergency Batteries Temp Range: -20°C thru 50°C
- Max Whip Length for REM is 8ft

EM4W Integral 4 Watt LED

EM8W Integral 8 Watt LED

REM4W Remote 4 Watt LED

REM8W Remote 8 Watt LED

REM16W Remote 16 Watt LED

REM10W- Remote 10 Watt LED - Cold Weather
CW

OPTIONAL BEAM SPREADS

NOTE: Depiction of lumen distribution as depicted is subject to change minimally based upon selection of LED.

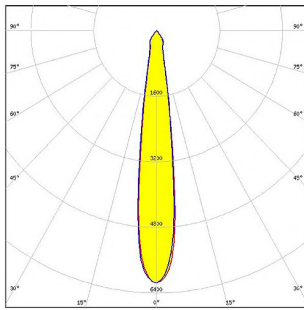

16° Spot (Wattage / Lumens)				
Watts	3000K	3500K	4000K	5000K
5W	649	693	702	711
10W	1491	1514	1533	1533
15W	2052	2084	2110	2136
25W	3229	3279	3321	3361

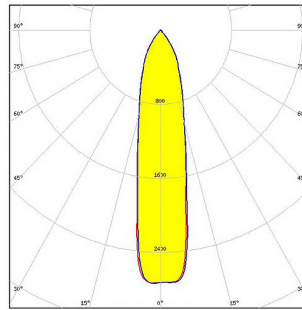

17° Spot (with Drop Lens) (Wattage / Lumens)				
Watts	3000K	3500K	4000K	5000K
5W	614	656	664	673
10W	1411	1433	1451	1469
15W	1942	1972	1996	2021
25W	3056	3102	3142	3181

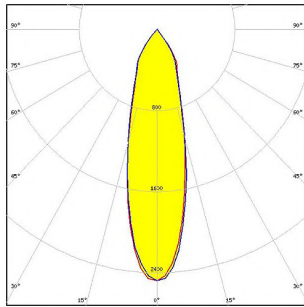

28° Medium (Wattage / Lumens)				
Watts	3000K	3500K	4000K	5000K
5W	649	693	702	711
10W	1491	1514	1533	1533
15W	2052	2084	2110	2136
25W	3229	3279	3321	3361

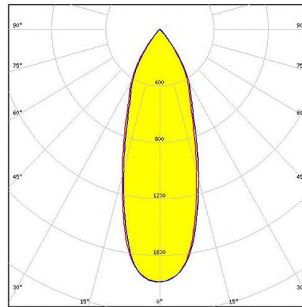

31° Medium (with Drop Lens) (Wattage / Lumens)				
Watts	3000K	3500K	4000K	5000K
5W	621	663	671	680
10W	1427	1449	1467	1486
15W	1964	1994	2019	2044
25W	3090	3138	3178	3217

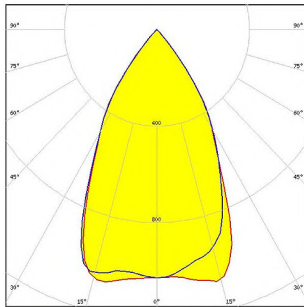

58° Wide (Wattage / Lumens)				
Watts	3000K	3500K	4000K	5000K
5W	642	686	694	703
10W	1475	1498	1517	1536
15W	2030	2061	2087	2113
25W	3195	3243	3285	3325

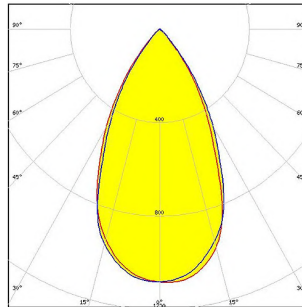

59° Wide (with Drop Lens) (Wattage / Lumens)				
Watts	3000K	3500K	4000K	5000K
5W	614	656	664	673
10W	1411	1433	1451	1469
15W	1942	1972	1996	2021
25W	3056	3102	3142	3181

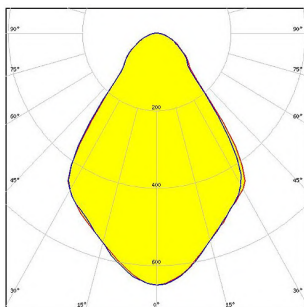

74° Extra Wide (Wattage / Lumens)				
Watts	3000K	3500K	4000K	5000K
5W	656	701	709	719
10W	1507	1531	1550	1570
15W	2074	2106	2132	2159
25W	3264	3314	3356	3398

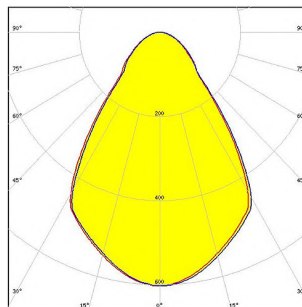

73° Extra Wide (with Drop Lens) (Wattage / Lumens)				
Watts	3000K	3500K	4000K	5000K
5W	635	678	687	696
10W	1459	1482	1500	1519
15W	2008	2039	2064	2090
25W	3160	3208	3249	3289

PHOTOMETRIC DATA

Test # 103096176CHI-011

CATALOGUE #: BFL-PM-AC-LU30-W-HXCL-LD40-XW-CT35

Test Date: 2/4/2019 — Tested in accordance with LM-79-80. The results contained in this summary report pertain only to the tested sample.

Summary of Results						
Lamp Output	Lumen Efficacy	Input Wattage	Color Temp	BUG Rating	Mounting	Distribution Style
7993.5 Lumens	115.2 LPW	69.4W	3500K	B3-U5-G0	Pendant Cable	Up (Wide) / Down (Extra Wide)

